

DC geared motors with brushes - 2 Nm 3.9 Watts - 3.9 Watts

Selling points of the range

A range of D.C. geared motors with ovoid gearbox.

- + Mechanical rating of gearbox with output shaft stalled : 2 Nm.
- + 3.9 Watt motor versions.
- + Available in either 12 or 24 V D.C.
- + Gearbox ratios options for 0.36 to 430 rpm.
- + Alternative shaft options.



Part number characteristics	82 869 001
Type	82 869 0
Voltage	12 V
Output speed (rpm)	108
Ratios (i)	40
General characteristics	
Motor	82 860 0
Gearbox	81 033 0
Maximum permitted torque from gearmotor under continuous conditions for 1 millions turns (Nm)	2
Axial load static (daN)	1
Radial load static (daN)	10
Max. output (W)	3.9
Nominal output (W)	3
Gearbox case temperature rise (°C)	50
Weight (g)	240
Product available	stocked item

General characteristics

Dimensions

82 869 0

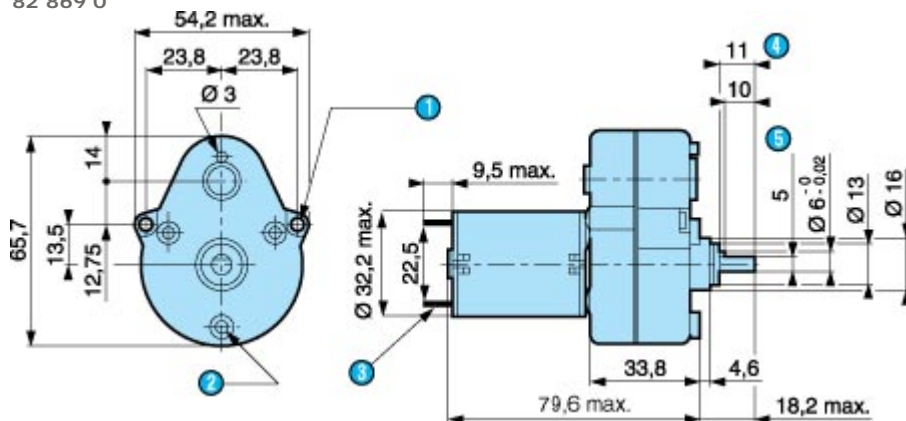

N° Legend

1	2 fixing holes Ø 3.2
2	3 bosses Ø 7.2 at 120° on R=19.5 with 3
3	2 tags NFC 20-120 series 2.8 x 0.5 mm
4	(shaft pushed-in ←)
5	5 mm across flats

Zoom

Shaft 79 202 573

N° Legend

1	(shaft pushed-in ←)
2	5 across flat

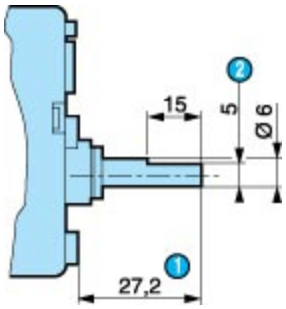

Zoom

Curves

Nominal speed and torque curves

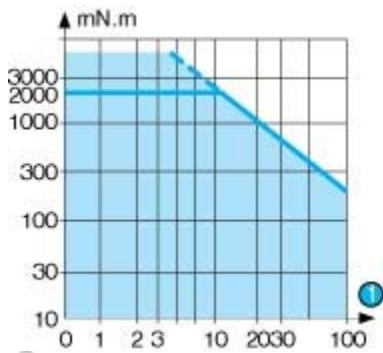

Zoom

N^o Legend
1 RPM
